

# PRODUCT SPECIFICATIONS / INFO

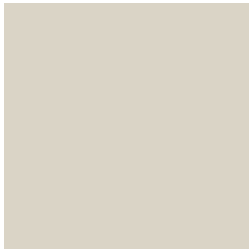

**Color:** Ivory



**NEMA:** 5-15R

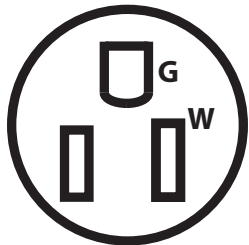

## Newer Technology Power2USB NWTPWR2U15ATRI

**UPC Code:** 811643012738

**Country Of Origin:** China

### Description:

**AC Description:** 15 Amp Tamper Resistant, 125 Volt, NEMA 5-15R, 2P, 3W, Decora Body Duplex Receptacle, Straight Blade, Residential Grade, Self Grounding, Back & Side Wired, Steel Strap - Ivory

**DC Description:** 5.2 Volt, 2500mA (12.5W) Duplex USB Charging Receptacle, With Integrated On/Off Safety Switch for USB Power

### Product Features

#### AC Horsepower Ratings

**At rated voltage:** 1/2HP

#### Electrical Specifications

<b>Grounding:</b>	Self
<b>Amperage:</b>	15 Amp
<b>Voltage:</b>	125 Volt
<b>NEMA:</b>	5-15R
<b>Pole:</b>	2
<b>Wire:</b>	3
<b>Dielectric Voltage:</b>	Withstands 2000V per UL 498
<b>Overload Test, HP Rating:</b>	125V AC, 58.8A
<b>Current Limiting:</b>	Full Rated Current
<b>Temperature Rise:</b>	Maximum contact temperature rise 27.6°C; Max terminal temperature rise 19.8 °C

#### Environmental Specifications

<b>Flamability:</b>	Rated V-2 per UL94
<b>Operating Temperature:</b>	-40C to 60C

#### Material Specifications

<b>Face Material:</b>	Polycarbonate
<b>Body Material:</b>	Polycarbonate
<b>Line Contacts:</b>	Brass Triple-Wipe .031 Thick
<b>Terminal Screws:</b>	Brass 10-32
<b>Grounding Screw:</b>	Brass 8-32
<b>Strap Material:</b>	Zinc-Plated Steel
<b>Clamp Nuts:</b>	Zinc-Plated Steel
<b>Ground Clips:</b>	Brass-Plated
<b>Color:</b>	Ivory

## Mechanical Specifications

<b>Terminal ID:</b>	Brass-Hot, Green-Ground, Silver-Neutral
<b>Terminal Accomodation:</b>	14-10 AWG
<b>Product ID:</b>	Ratings are marked on device
<b>Termination:</b>	Side

## Standards and Certifications

<b>NEMA:</b>	WD-1 & WD-6
<b>ANSI:</b>	C-73
<b>UL 498:</b>	File E339607
<b>UL 514D:</b>	File E339607
<b>UL 1310:</b>	File E339607
<b>CAN/CSA C22.2 No. 223:</b>	File E339607
<b>Warranty:</b>	1 Year

**Patent Number** US 7,997,925 B2

## Wiring Diagram

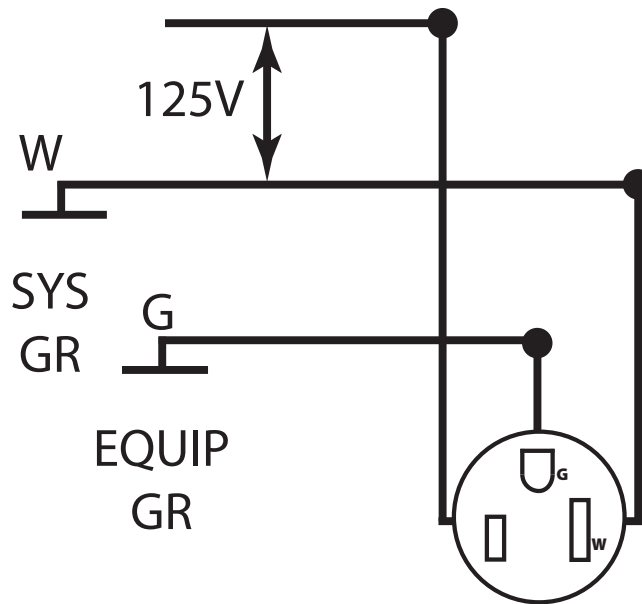

# 5-15R

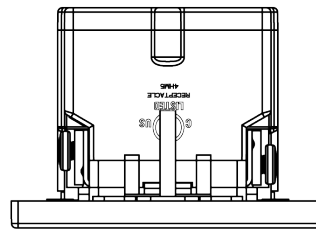
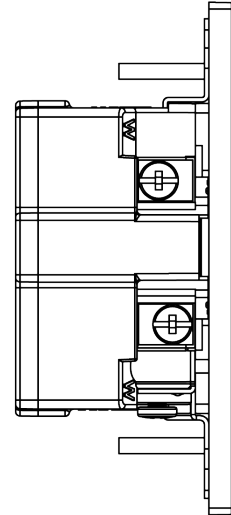
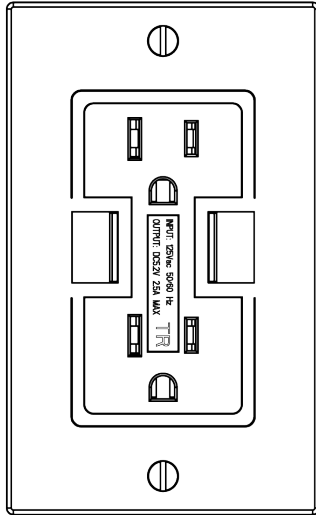
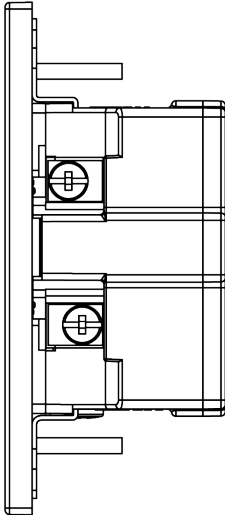
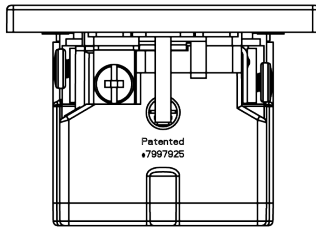
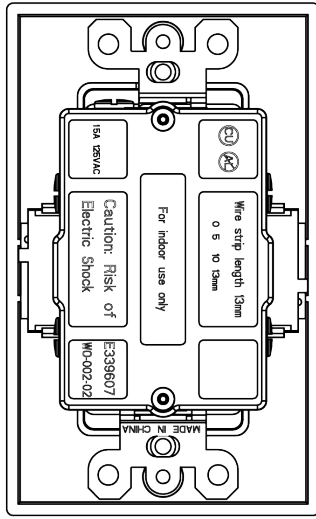

**Newer Technology, Inc.**  
 2650 Bridge Lane, Woodstock, IL 60098  
 Telephone: (815) 308-7001